

NDF60N550U1, NDD60N550U1

Product Preview

N-Channel Power MOSFET 600 V, 550 mΩ

Features

- 100% Avalanche Tested
- These Devices are Pb-Free, Halogen Free/BFR Free and are RoHS Compliant

ABSOLUTE MAXIMUM RATINGS ($T_J = 25^\circ\text{C}$ unless otherwise noted)

Parameter			Symbol	NDF	NDD	Unit
Drain-to-Source Voltage			V_{DS}	600		V
Gate-to-Source Voltage			V_{GS}	± 25		V
Continuous Drain Current $R_{\theta JC}$ (Note 1)	Steady State	$T_C = 25^\circ\text{C}$	I_D	9.5	8.5	A
		$T_C = 100^\circ\text{C}$		6	5.4	
Power Dissipation – $R_{\theta JC}$	Steady State	$T_C = 25^\circ\text{C}$	P_D	28	96	W
Pulsed Drain Current	$t_p = 10 \mu\text{s}$		I_{DM}	38	34	A
Operating Junction and Storage Temperature			T_J, T_{STG}	-55 to +150		$^\circ\text{C}$
Source Current (Body Diode)			I_S	9.5	8.5	A
Single Pulse Drain-to-Source Avalanche Energy			EAS	TBD		mJ
Lead Temperature for Soldering Leads			T_L	260		$^\circ\text{C}$

Stresses exceeding Maximum Ratings may damage the device. Maximum Ratings are stress ratings only. Functional operation above the Recommended Operating Conditions is not implied. Extended exposure to stresses above the Recommended Operating Conditions may affect device reliability.

1. Limited by maximum junction temperature

THERMAL RESISTANCE

Parameter	Symbol	Value	Unit
Junction-to-Case (Drain) NDF60N550U1 NDD60N550U1	$R_{\theta JC}$	4.4 1.3	$^\circ\text{C}/\text{W}$
Junction-to-Ambient Steady State NDF60N550U1 NDD60N550U1 NDD60N550U1-1	$R_{\theta JA}$	50 33 96	$^\circ\text{C}/\text{W}$

This document contains information on a product under development. ON Semiconductor reserves the right to change or discontinue this product without notice.



ON Semiconductor®

<http://onsemi.com>

$V_{(BR)DSS}$	$R_{DS(ON) MAX}$
600 V	550 mΩ @ 10 V

N-Channel MOSFET

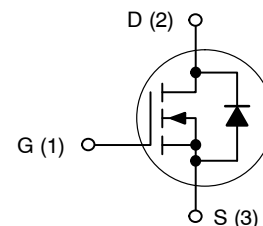

TO-220FP
CASE 221AH



IPAK
CASE 369D

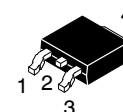

DPAK
CASE 369AA

MARKING AND ORDERING INFORMATION

See detailed ordering and shipping information in the package dimensions section on page 3 of this data sheet.

NDF60N550U1, NDD60N550U1

ELECTRICAL CHARACTERISTICS ($T_J = 25^\circ\text{C}$ unless otherwise noted)

Characteristic	Symbol	Test Conditions	Min	Typ	Max	Unit
----------------	--------	-----------------	-----	-----	-----	------

OFF CHARACTERISTICS

Drain-to-Source Breakdown Voltage	$V_{(BR)DSS}$	$V_{GS} = 0\text{ V}, I_D = 1\text{ mA}$	600			V
Drain-to-Source Breakdown Voltage Temperature Coefficient	$V_{(BR)DSS}/T_J$			TBD		$\text{mV}/^\circ\text{C}$
Drain-to-Source Leakage Current	I_{DSS}	$V_{DS} = 600\text{ V}, V_{GS} = 0\text{ V}$	$T_J = 25^\circ\text{C}$		1	μA
			$T_J = 125^\circ\text{C}$		50	
Gate-to-Source Leakage Current	I_{GSS}	$V_{GS} = \pm 20\text{ V}$			± 100	nA

ON CHARACTERISTICS (Note 2)

Gate Threshold Voltage	$V_{GS(TH)}$	$V_{DS} = V_{GS}, I_D = 50\ \mu\text{A}$	2	TBD	4	V
Negative Threshold Temperature Coefficient	$V_{GS(TH)}/T_J$	Reference to $25^\circ\text{C}, I_D = 50\ \mu\text{A}$		TBD		$\text{mV}/^\circ\text{C}$
Static Drain-to-Source On Resistance	$R_{DS(on)}$	$V_{GS} = 10\text{ V}, I_D = 4.8\text{ A}$		530	550	$\text{m}\Omega$
Forward Transconductance	g_{FS}	$V_{DS} = 15\text{ V}, I_D = 4.8\text{ A}$		TBD		S

DYNAMIC CHARACTERISTICS

Input Capacitance	C_{iss}	$V_{DS} = 50\text{ V}, V_{GS} = 0\text{ V}, f = 1\text{ MHz}$		540		pF
Output Capacitance	C_{oss}			45		
Reverse Transfer Capacitance	C_{rss}			1		
Total Gate Charge	Q_g	$V_{DS} = 300\text{ V}, I_D = 9.5\text{ A}, V_{GS} = 10\text{ V}$		20		nC
Gate-to-Source Charge	Q_{gs}			TBD		
Gate-to-Drain Charge	Q_{gd}			TBD		
Plateau Voltage	V_{GP}			TBD		
Gate Resistance	R_g			TBD		Ω

RESISTIVE SWITCHING CHARACTERISTICS (Note 3)

Turn-on Delay Time	$t_{d(on)}$	$V_{DD} = 300\text{ V}, I_D = 9.5\text{ A}, V_{GS} = 10\text{ V}, R_G = 0\ \Omega$		TBD		ns
Rise Time	t_r			TBD		
Turn-off Delay Time	$t_{d(off)}$			TBD		
Fall Time	t_f			TBD		

SOURCE-DRAIN DIODE CHARACTERISTICS

Diode Forward Voltage	V_{SD}	$I_S = 9.5\text{ A}, V_{GS} = 0\text{ V}$	$T_J = 25^\circ\text{C}$		TBD	1.6	V
			$T_J = 100^\circ\text{C}$		TBD		
Reverse Recovery Time	t_{rr}	$V_{GS} = 0\text{ V}, V_{DD} = 30\text{ V}, I_S = 9.5\text{ A}, d_i/d_t = 100\text{ A}/\mu\text{s}$			TBD		ns
Charge Time	t_a				TBD		
Discharge Time	t_b				TBD		
Reverse Recovery Charge	Q_{rr}				TBD		

2. Pulse Width $\leq 300\ \mu\text{s}$, Duty Cycle $\leq 2\%$.

3. Switching characteristics are independent of operating junction temperatures.

NDF60N550U1, NDD60N550U1

MARKING DIAGRAMS

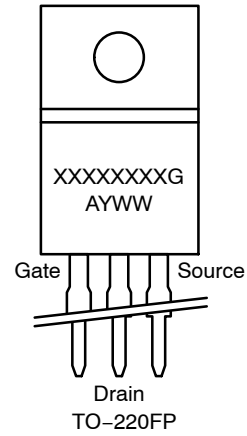
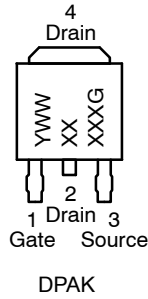
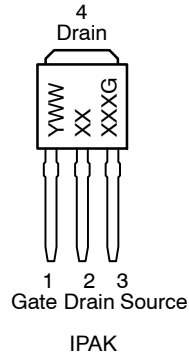

A = Assembly Location
 Y = Year
 WW = Work Week
 G = Pb-Free Package

ORDERING INFORMATION

Device	Package	Shipping [†]
NDF60N550U1G	TO-220FP (Pb-Free, Halogen-Free)	50 Units / Rail
NDD60N550U1-1G	IPAK (Pb-Free, Halogen-Free)	75 Units / Rail
NDD60N550U1T4G	DPAK (Pb-Free, Halogen-Free)	2500 / Tape & Reel

[†]For information on tape and reel specifications, including part orientation and tape sizes, please refer to our Tape and Reel Packaging Specifications Brochure, BRD8011/D.

NDF60N550U1, NDD60N550U1

PACKAGE DIMENSIONS

TO-220 FULLPACK, 3-LEAD
CASE 221AH
ISSUE C

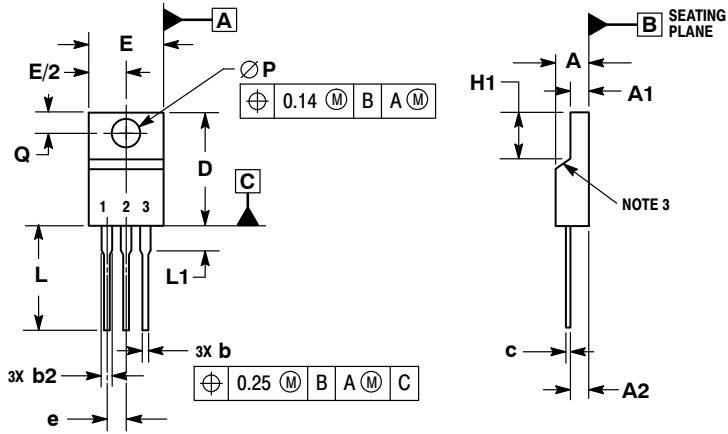

NOTES:

1. DIMENSIONING AND TOLERANCING PER ASME Y14.5M, 1994.
2. CONTROLLING DIMENSION: MILLIMETERS.
3. CONTOUR UNCONTROLLED IN THIS AREA.
4. DIMENSIONS D AND E DO NOT INCLUDE MOLD FLASH AND GATE PROTRUSIONS. MOLD FLASH AND GATE PROTRUSIONS NOT TO EXCEED 0.13 PER SIDE. THESE DIMENSIONS ARE TO BE MEASURED AT OUTERMOST EXTREME OF THE PLASTIC BODY.
5. DIMENSION b2 DOES NOT INCLUDE DAMBAR PROTRUSION. LEAD WIDTH INCLUDING PROTRUSION SHALL NOT EXCEED 2.00.

MILLIMETERS		
DIM	MIN	MAX
A	4.30	4.70
A1	2.50	2.90
A2	2.50	2.70
b	0.54	0.84
b2	1.10	1.40
c	0.49	0.79
D	14.70	15.30
E	9.70	10.30
e	2.54 BSC	
H1	6.70	7.10
L	12.70	14.73
L1	---	2.80
P	3.00	3.40
Q	2.80	3.20

NDF60N550U1, NDD60N550U1

PACKAGE DIMENSIONS

IPAK
CASE 369D-01
ISSUE C

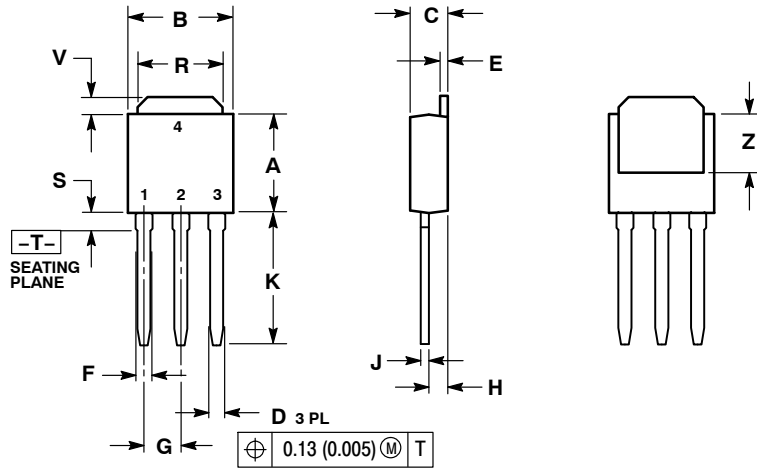

- NOTES:
1. DIMENSIONING AND TOLERANCING PER ANSI Y14.5M, 1982.
2. CONTROLLING DIMENSION: INCH.

DIM	INCHES		MILLIMETERS	
	MIN	MAX	MIN	MAX
A	0.235	0.245	5.97	6.35
B	0.250	0.265	6.35	6.73
C	0.086	0.094	2.19	2.38
D	0.027	0.035	0.69	0.88
E	0.018	0.023	0.46	0.58
F	0.037	0.045	0.94	1.14
G	0.090	BSC	2.29	BSC
H	0.034	0.040	0.87	1.01
J	0.018	0.023	0.46	0.58
K	0.350	0.380	8.89	9.65
R	0.180	0.215	4.45	5.45
S	0.025	0.040	0.63	1.01
V	0.035	0.050	0.89	1.27
Z	0.155	---	3.93	---

- STYLE 2:
PIN 1. GATE
2. DRAIN
3. SOURCE
4. DRAIN

NDF60N550U1, NDD60N550U1

PACKAGE DIMENSIONS

DDPAK (SINGLE GAUGE) CASE 369AA-01 ISSUE B

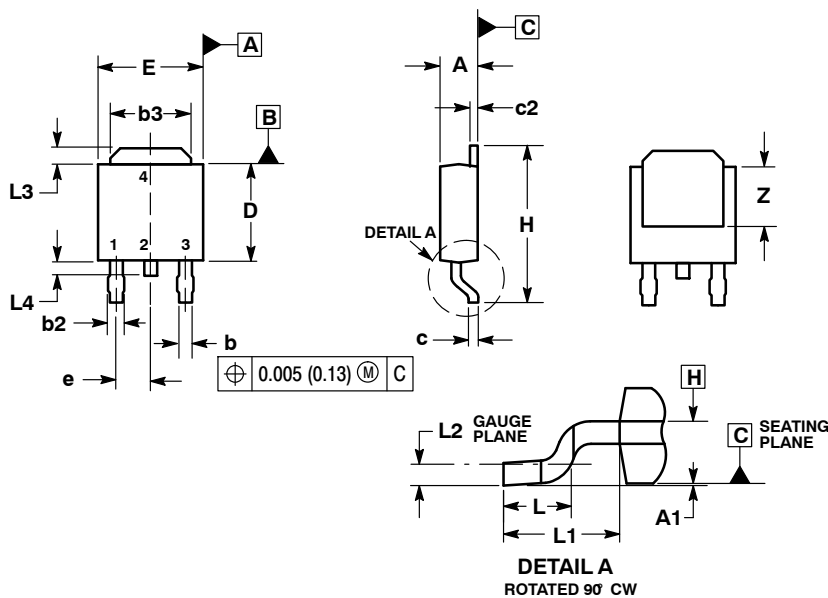

NOTES:

1. DIMENSIONING AND TOLERANCING PER ASME Y14.5M, 1994.
2. CONTROLLING DIMENSION: INCHES.
3. THERMAL PAD CONTOUR OPTIONAL WITHIN DIMENSIONS b3, L3 and Z.
4. DIMENSIONS D AND E DO NOT INCLUDE MOLD FLASH, PROTRUSIONS, OR BURRS. MOLD FLASH, PROTRUSIONS, OR GATE BURRS SHALL NOT EXCEED 0.006 INCHES PER SIDE.
5. DIMENSIONS D AND E ARE DETERMINED AT THE OUTERMOST EXTREMES OF THE PLASTIC BODY.
6. DATUMS A AND B ARE DETERMINED AT DATUM PLANE H.

DIM	INCHES		MILLIMETERS	
	MIN	MAX	MIN	MAX
A	0.086	0.094	2.18	2.38
A1	0.000	0.005	0.00	0.13
b	0.025	0.035	0.63	0.89
b2	0.030	0.045	0.76	1.14
b3	0.180	0.215	4.57	5.46
c	0.018	0.024	0.46	0.61
c2	0.018	0.024	0.46	0.61
D	0.235	0.245	5.97	6.22
E	0.250	0.265	6.35	6.73
e	0.090	BSC	2.29	BSC
H	0.370	0.410	9.40	10.41
L	0.055	0.070	1.40	1.78
L1	0.108	REF	2.74	REF
L2	0.020	BSC	0.51	BSC
L3	0.035	0.050	0.89	1.27
L4	---	0.040	---	1.01
Z	0.155	---	3.93	---

SOLDERING FOOTPRINT*

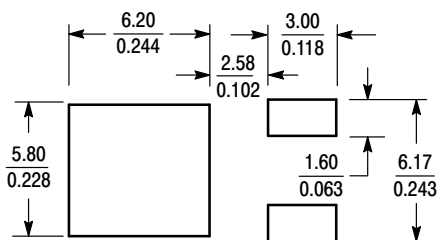

SCALE 3:1 (mm/inches)

STYLE 2:

- PIN 1. GATE
2. DRAIN
3. SOURCE
4. DRAIN

*For additional information on our Pb-Free strategy and soldering details, please download the ON Semiconductor Soldering and Mounting Techniques Reference Manual, SOLDERRM/D.

ON Semiconductor and are registered trademarks of Semiconductor Components Industries, LLC (SCILLC). SCILLC owns the rights to a number of patents, trademarks, copyrights, trade secrets, and other intellectual property. A listing of SCILLC's product/patent coverage may be accessed at www.onsemi.com/site/pdf/Patent-Marking.pdf. SCILLC reserves the right to make changes without further notice to any products herein. SCILLC makes no warranty, representation or guarantee regarding the suitability of its products for any particular purpose, nor does SCILLC assume any liability arising out of the application or use of any product or circuit, and specifically disclaims any and all liability, including without limitation special, consequential or incidental damages. "Typical" parameters which may be provided in SCILLC data sheets and/or specifications can and do vary in different applications and actual performance may vary over time. All operating parameters, including "Typicals" must be validated for each customer application by customer's technical experts. SCILLC does not convey any license under its patent rights nor the rights of others. SCILLC products are not designed, intended, or authorized for use as components in systems intended for surgical implant into the body, or other applications intended to support or sustain life, or for any other application in which the failure of the SCILLC product could create a situation where personal injury or death may occur. Should Buyer purchase or use SCILLC products for any such unintended or unauthorized application, Buyer shall indemnify and hold SCILLC and its officers, employees, subsidiaries, affiliates, and distributors harmless against all claims, costs, damages, and expenses, and reasonable attorney fees arising out of, directly or indirectly, any claim of personal injury or death associated with such unintended or unauthorized use, even if such claim alleges that SCILLC was negligent regarding the design or manufacture of the part. SCILLC is an Equal Opportunity/Affirmative Action Employer. This literature is subject to all applicable copyright laws and is not for resale in any manner.

PUBLICATION ORDERING INFORMATION

LITERATURE FULFILLMENT:
Literature Distribution Center for ON Semiconductor
P.O. Box 5163, Denver, Colorado 80217 USA
Phone: 303-675-2175 or 800-344-3860 Toll Free USA/Canada
Fax: 303-675-2176 or 800-344-3867 Toll Free USA/Canada
Email: orderlit@onsemi.com

N. American Technical Support: 800-282-9855 Toll Free USA/Canada
Europe, Middle East and Africa Technical Support:
Phone: 421 33 790 2910
Japan Customer Focus Center
Phone: 81-3-5817-1050

ON Semiconductor Website: www.onsemi.com
Order Literature: <http://www.onsemi.com/orderlit>

For additional information, please contact your local Sales Representative